

## « Chanson en laisse »

Poser la première image de la liste sur la table.

Les autres images sont posées face visible devant les enfants.

Les élèves doivent retrouver l'image qui suit (fin du mot, début du mot suivant).

L'enseignant doit préalablement s'assurer de la justesse et compréhension du lexique.

Ce jeu est difficile car il demande de la décentration par rapport au mot dit → plutôt CP-CE1.  
A faire absolument avec syllabe écrite sinon la laisse est cassée ou ne fonctionne pas : **BARRAGE-GENOU**. L'autocorrection n'étant pas possible, il faut forcément l'adulte pour valider.

*Merci à Nathalie Menguy et aux stagiaires des animations pédagogiques qui ont permis les améliorations du jeu.*

Remarque de fabrication : réduire les images à 7 cm pour pouvoir mettre une feuille de couleur de 8x8 cm en-dessous puis de pouvoir mettre 6 images sur une feuille à plastifier A4

Ce fichier, conçu par Anne Garro et Myriam Hamza, est mis à disposition selon les termes de la licence Creative Commons Paternité-Pas d'Utilisation Commerciale-Partage des Conditions Initiales à l'Identique, 2.0 France (<http://creativecommons.org/licenses/by-nc-sa/2.0/fr/>). Fichier créé en novembre 2007 1<sup>ère</sup> version, actualisé novembre 2008.

barrage → genou → nougat → gâteau → taureau → robinet  
→ nénuphar → pharmacie → citron → trompette

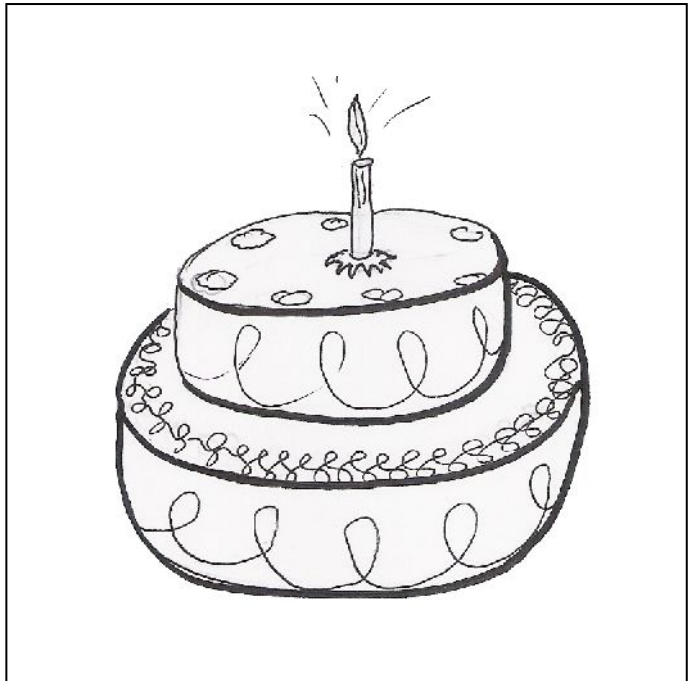
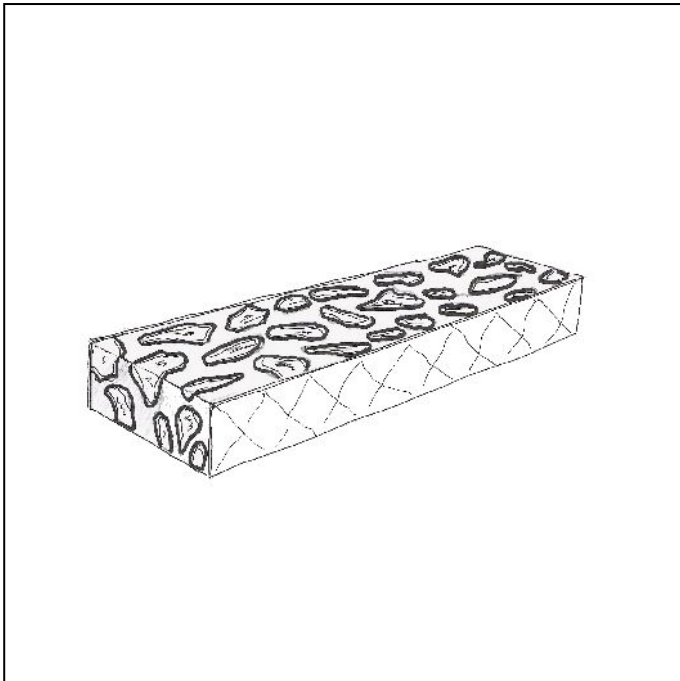
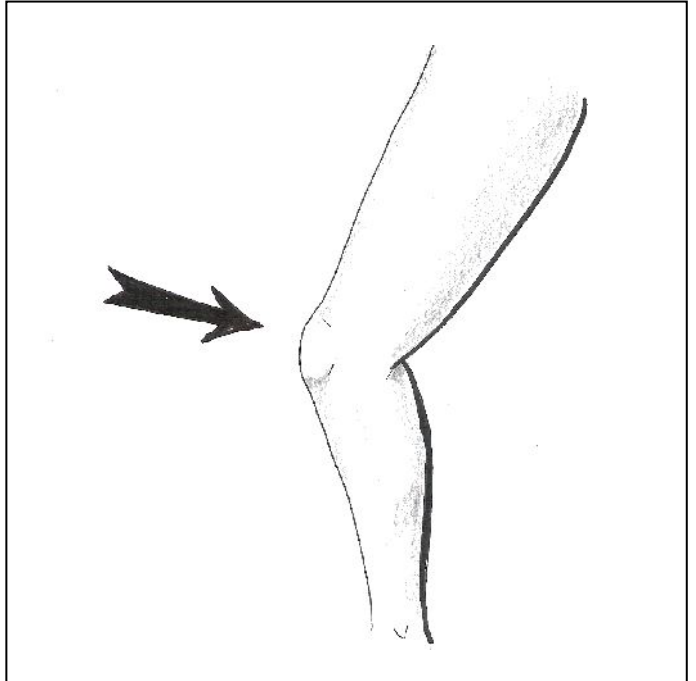
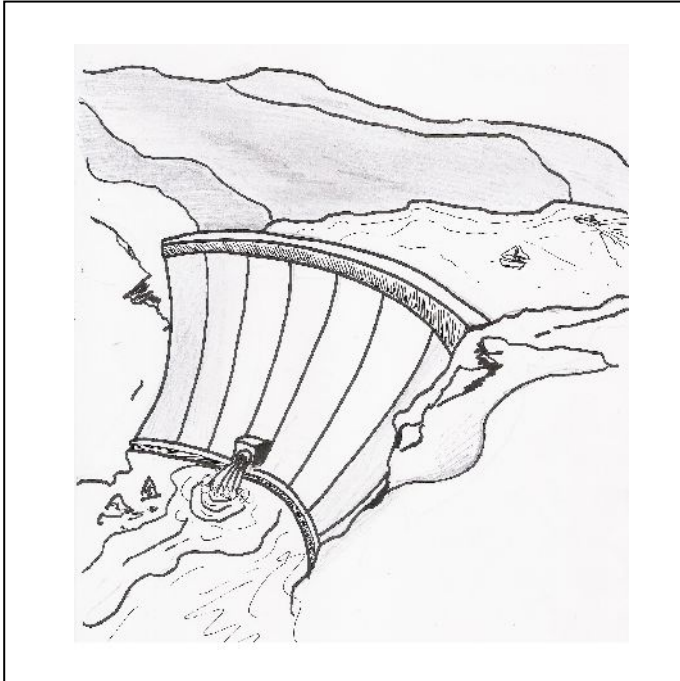

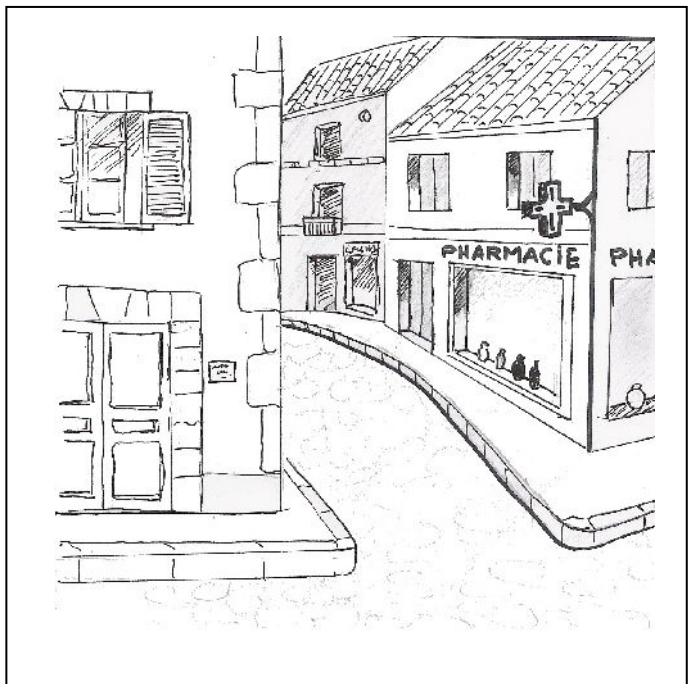
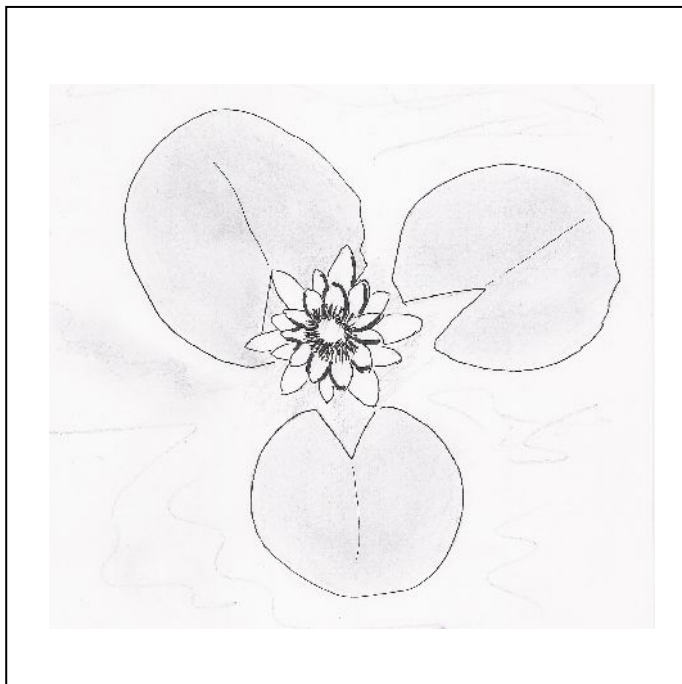
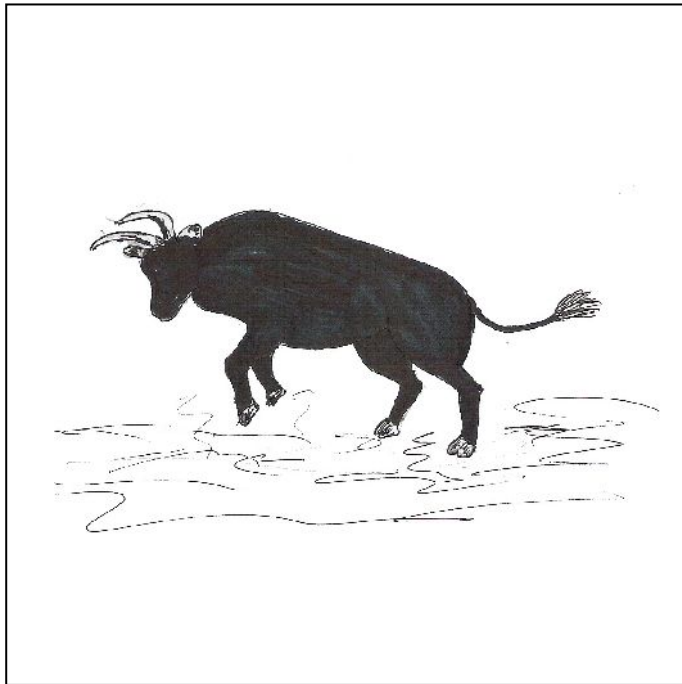

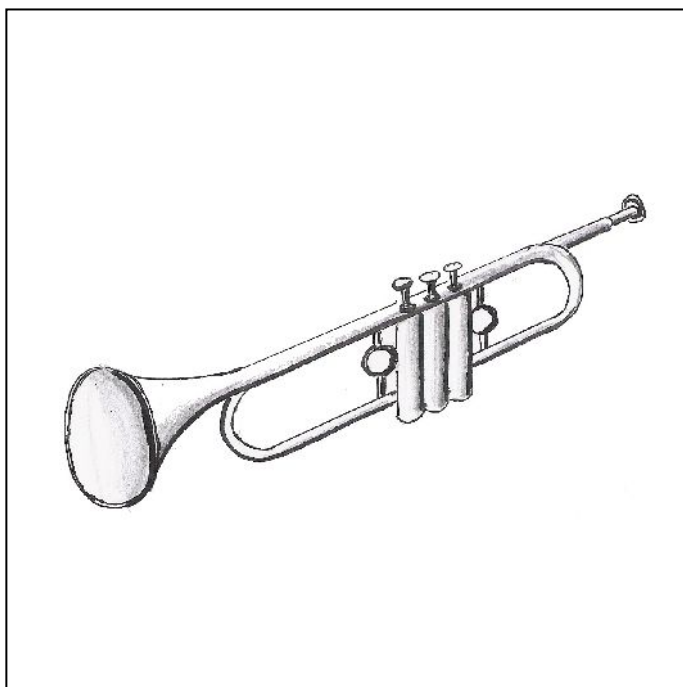
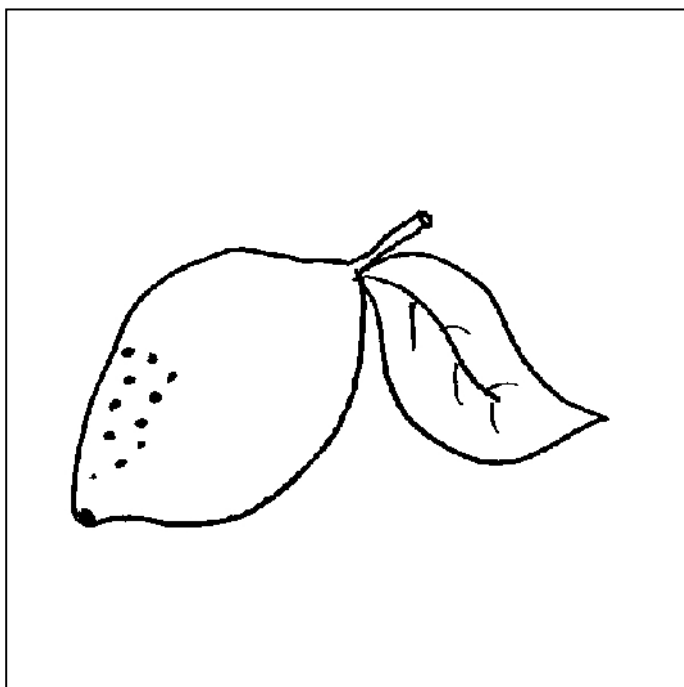

Orange → jeton → ombre → brebis → bijou → ours → serpent  
→ enveloppe → peluche → cheval

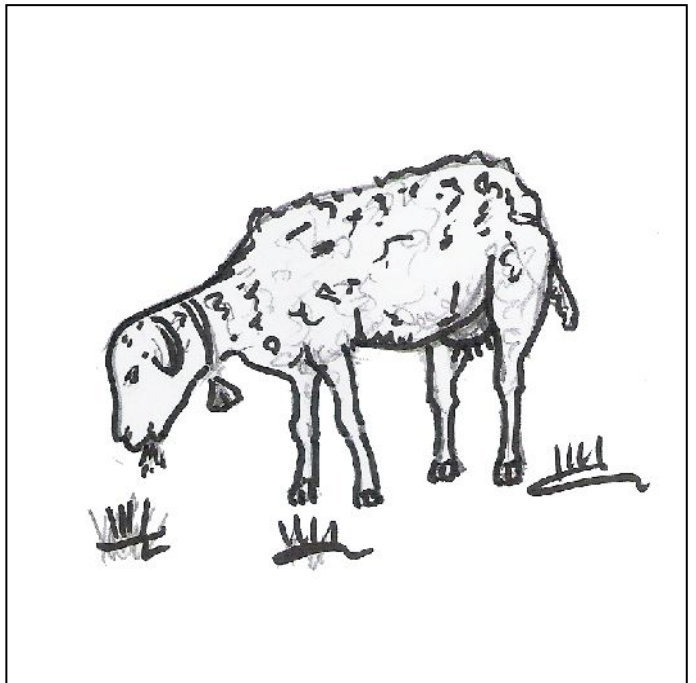
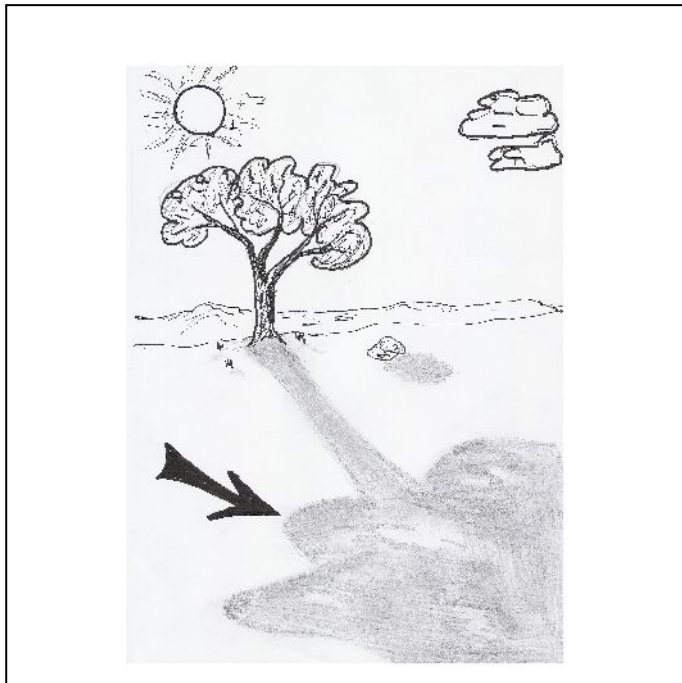
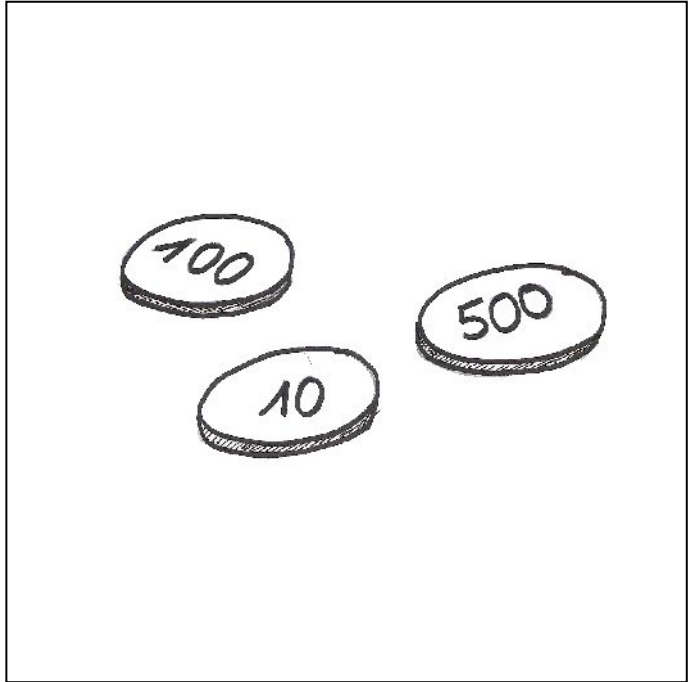
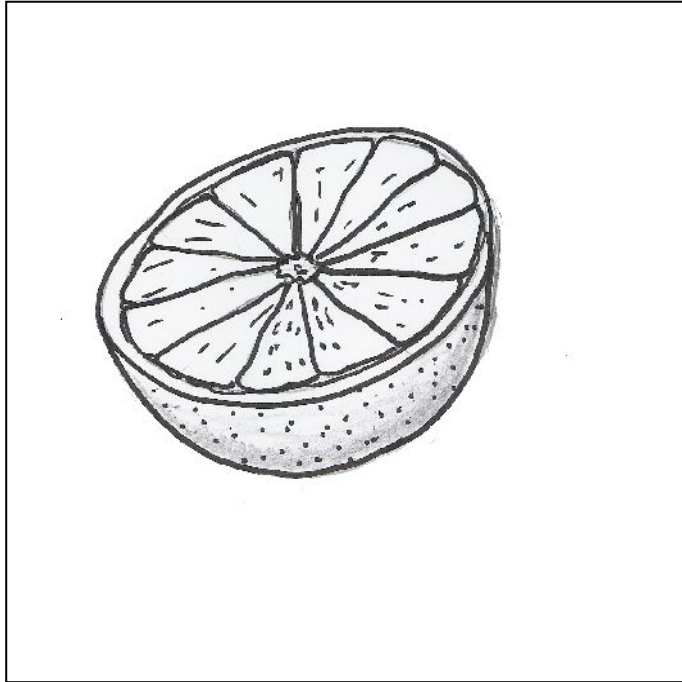

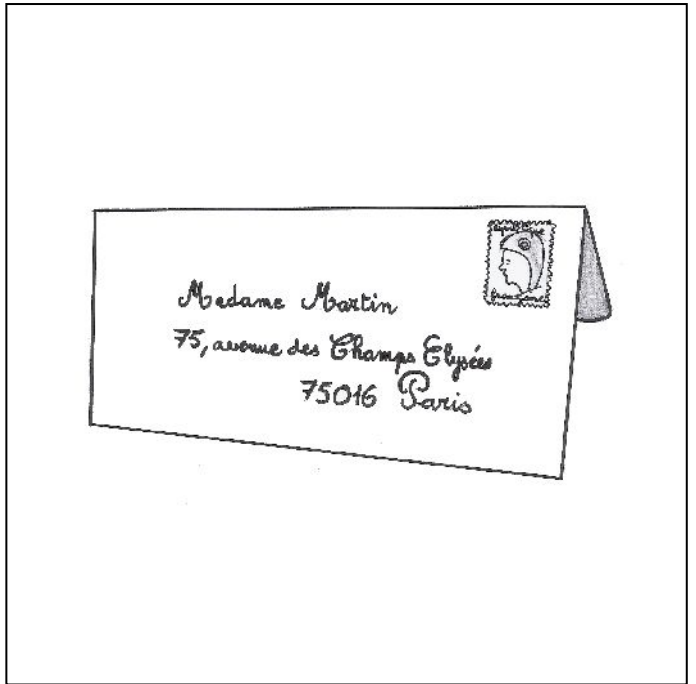
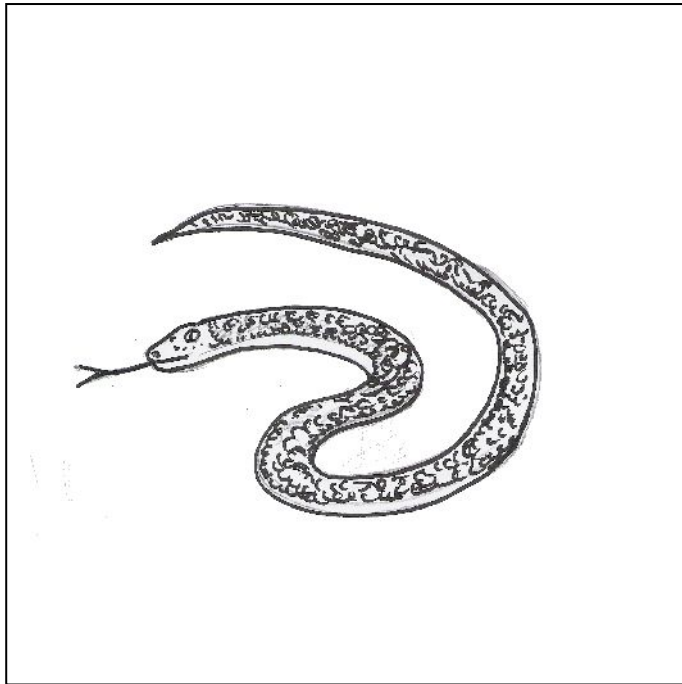
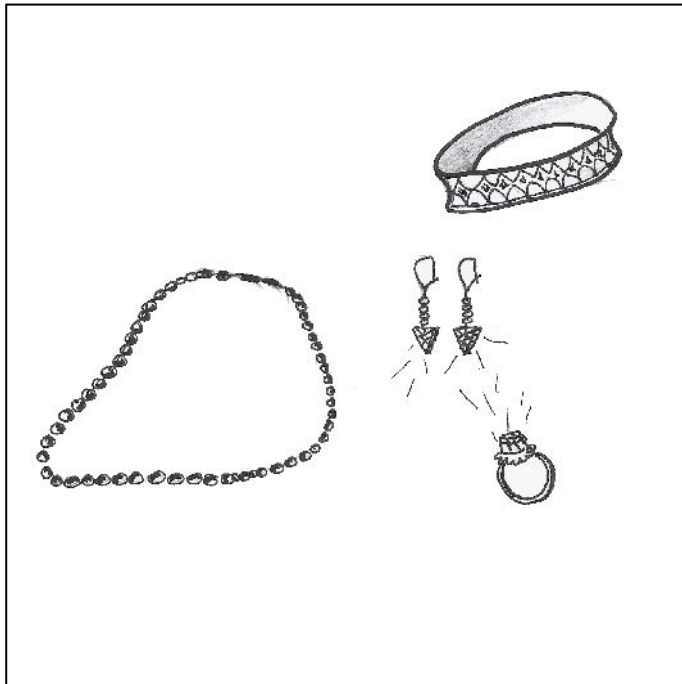

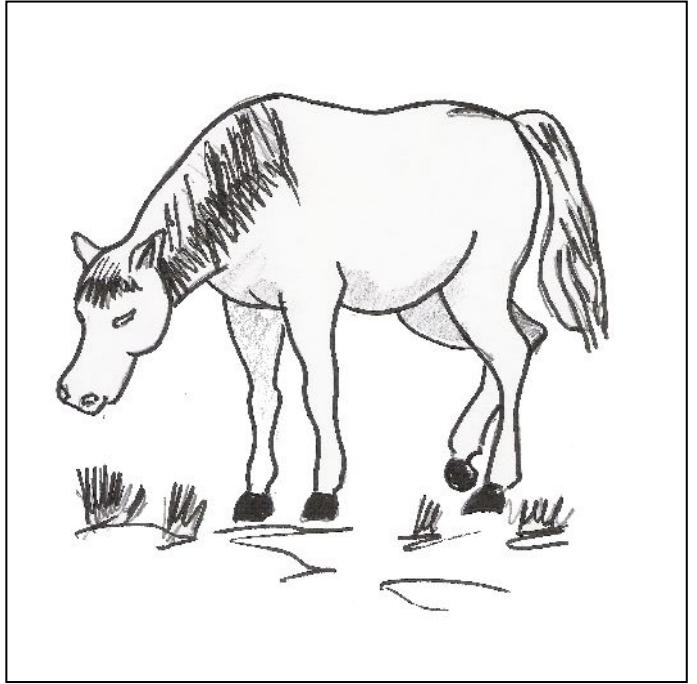
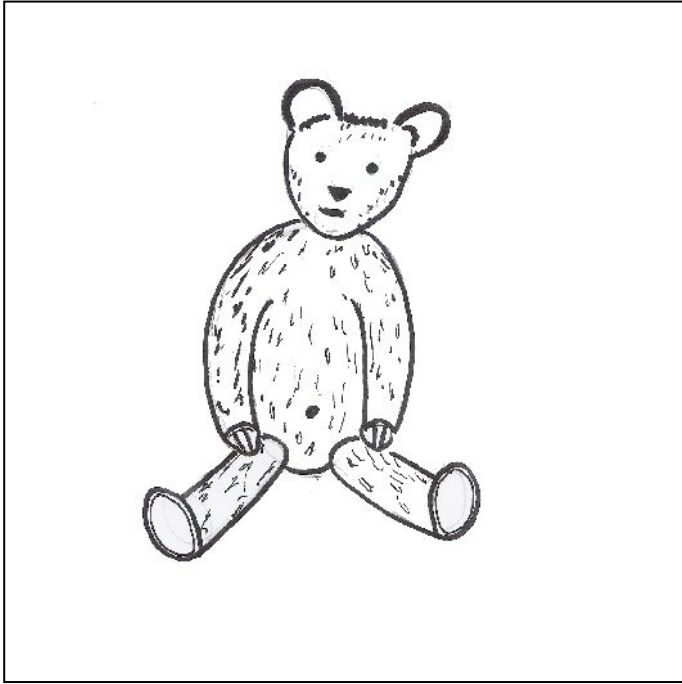

Tortue → tulipe → petit → tipi → pistolet → laitue → tuba →  
bateau → tonneau → Noël

Tortue → tuba → bateau → tonneau → Noël → laitue → tulipe  
→ petit → tipi → pistolet

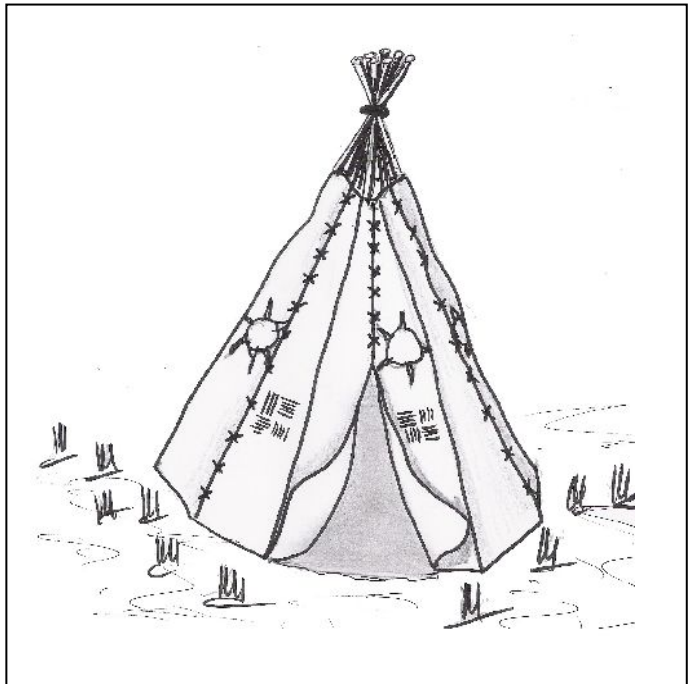
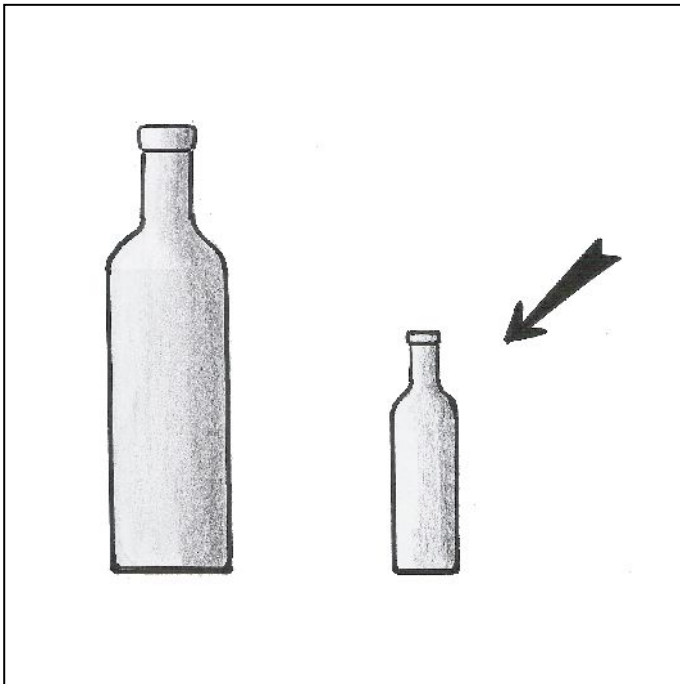
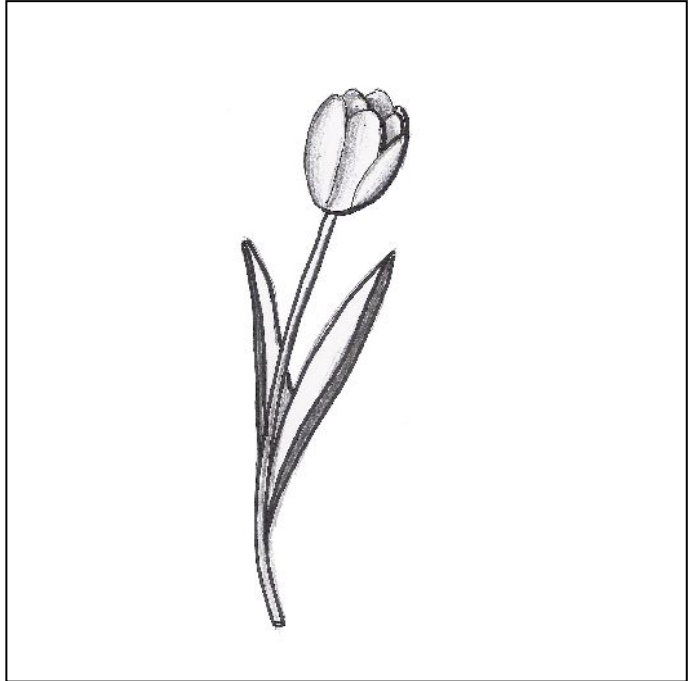
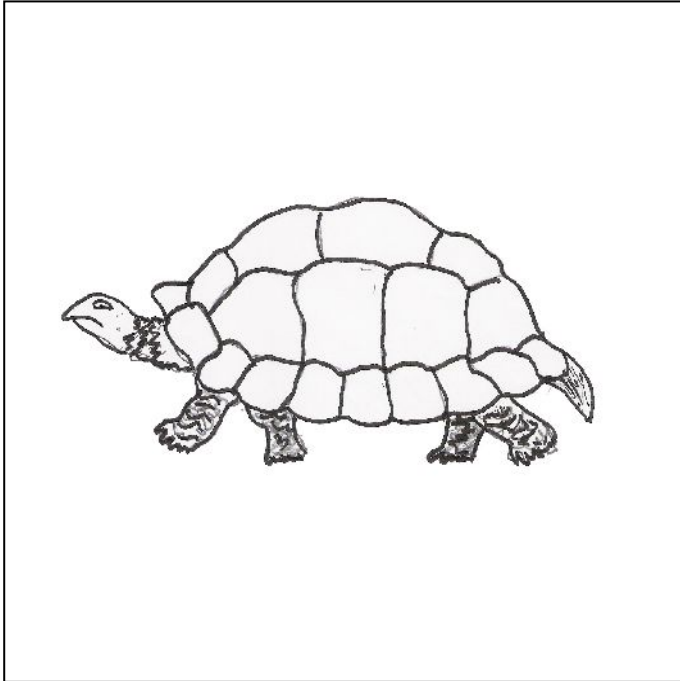



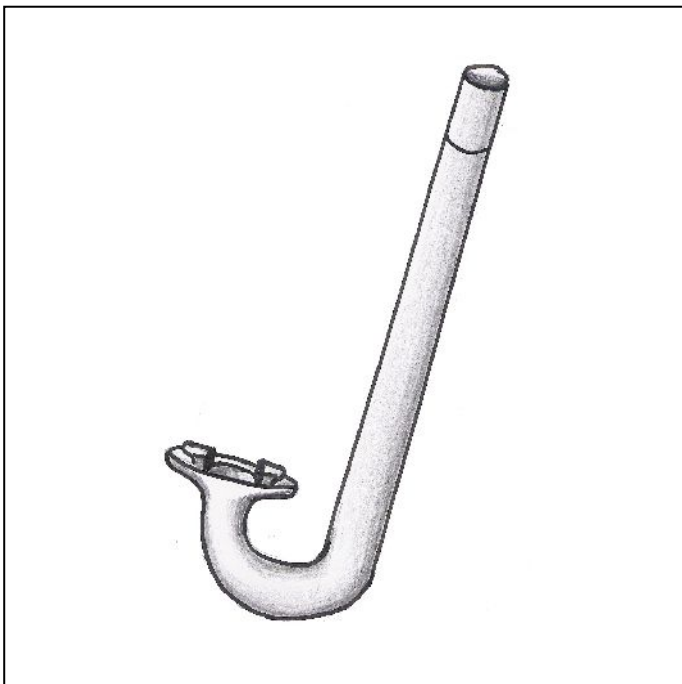
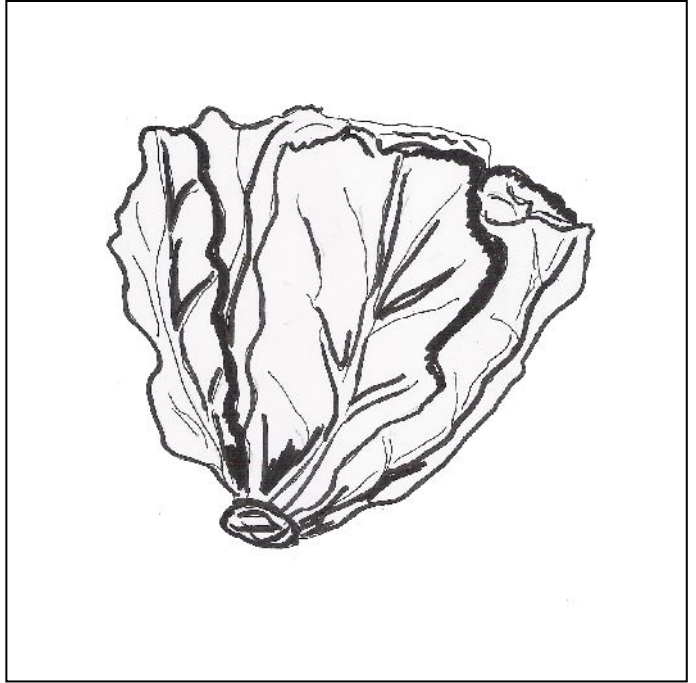
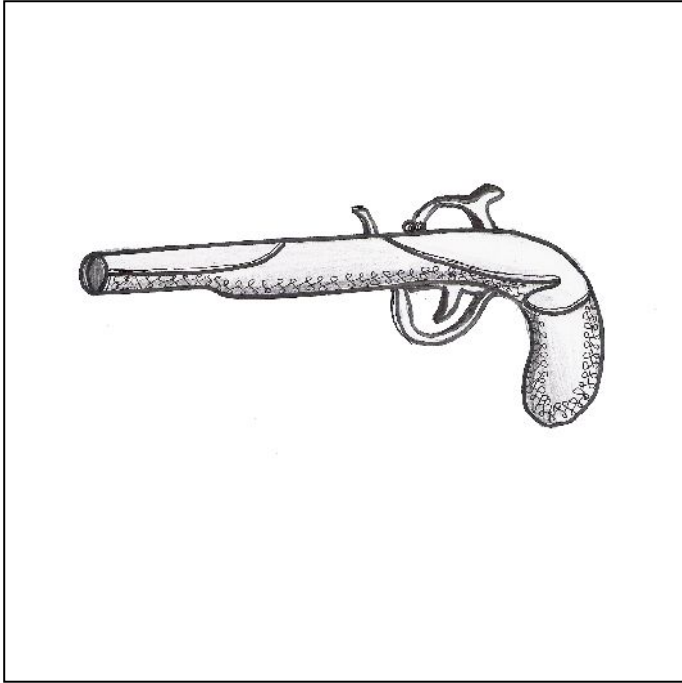

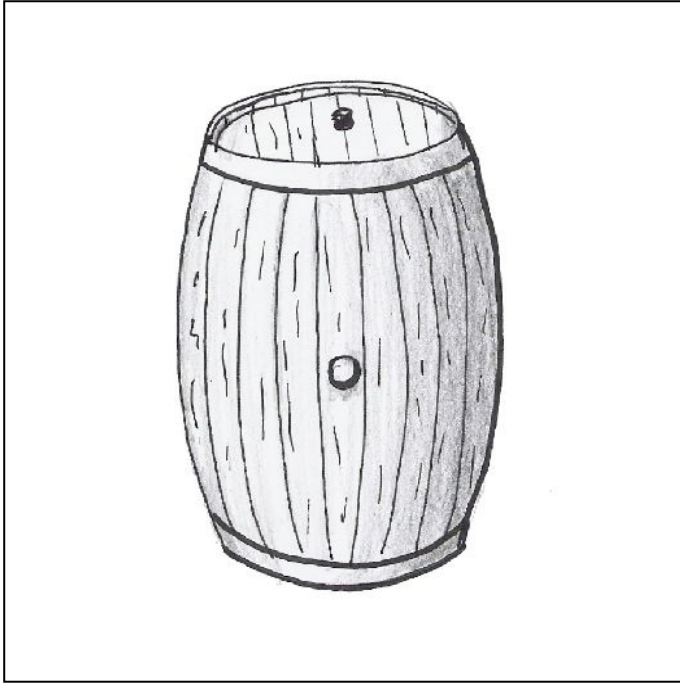

Rateau → toboggan → antilope → petit → tirelire → renard →  
artichaut → chocolat → lapin → pinceau → saucisson

